

# ProSeries XTP™

Thermostatic Water Heater for Commercial and Industrial Applications

## Specifications

Tankless Electric Water Heater

### Applications

- Booster (up to 180°F)
- Recirculation loop\*
- Washdown processes
- Commercial kitchens / utility sinks
- Kitchen, wet bar, utility sinks
- Mop sinks
- Dishwasher
- Handwashing (variable and fixed-flow)

### Performance Features

- Adaptive Stability Technology™ assesses the heater condition and shifts unit operation to ensure a consistent and reliable output
- Includes wall mounting bracket allowing for easy, flexible installation, reducing time and labor
- SafeStart™ engages upon start-up to avoid dry-fire occurrence
- 4-line, 20-character LED display delivers an enhanced user experience - display relays system status & operation feedback
- Built to last - constructed of powder-coated galvanized steel, stainless steel heating chambers and sheathed copper heating elements, protecting the heater and minimizing the occurrence of rust and corrosion
- Self-diagnostics with intelligent controls actively protect heater in installed environment
- Flow activation at 0.5 GPM/ 1.89 LPM across product line
- Max flow of 20 GPM
- Fittings suit common plumbing connections (3/4" NPT)
- Temperature stability at +/- 1°F or +/- 0.6°C output
- High temperature limit switch enables safe operation
- Powered by three phase delta, capable of supporting locations serviced by three phase wye or three phase delta power
- Only one input water line, cold or hot, needed for installation
- Factory set to 120°F
- Compact size for flexible installation
- User adjustable turn on flow
- User adjustable temperature settings 60° - 180°F
- Inlet/outlet thermistors for precise temperature control
- Tamper resistant controls (hardware lockout)
- IP25-rated cover prevents water intrusion within the system (water run-off and minimal corrosion)

### Optional Features (NEMA cabinet required)

- N4 (powder coated steel), N4X (304SS) N4X6 (316SS) enclosures
- Free standing legs
- Freeze protection for harsh climate, up to -30°F
- Non-fused or fused electrical disconnect
- GFCI
- Explosion proof – C1D2 Compliant, local certification required. Class Z purge and pressurization system provided with pressure switch for alarm controls. For classification other than C1D2 please contact the factory to discuss options.
- Siren and beacon - audible and visual alarm (C1D2 compliant when paired with explosion proof package)
- Display is visible regardless of NEMA cabinet selection

### Product Specifications

<b>Min. Operating Pressure:</b>	35 PSI
<b>Max. Operating Pressure:</b>	150 PSI
<b>Optimum Operating Pressure:</b>	60-90 PSI

\*In accordance with NEC guidelines, the water heater is designed for a maximum continuous duty cycle of 3 hrs. at 100% power output. After 3 hrs. heater should be powered down for long enough to return heater and electrical infrastructure to ambient temperature.

Information and product specifications contained in this document are subject to change without notice. REV 2020-01

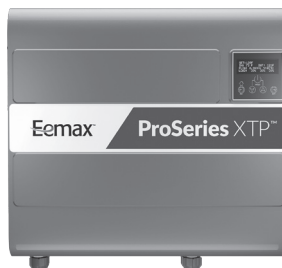

### Electrical configuration and requirements

All Eemax three phase units are custom made to order and as such, are non-returnable and non-refundable. Check your electrical supply, making sure all criteria for operating your Eemax water heater are met.

### Eemax 480V and 208V Three Phase Units Delta Configuration

Requires: 3 Lives and 1 Ground (earth)

ProSeries XTP is compatible with both delta and wye (Y) electrical configuration requirements. When converting a Y configured unit to a ProSeries XTP delta configured model, the neutral leg is not required.

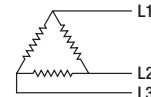

### Special Design Service

- Inquiries for units for unique applications are welcome. Call our Technical Service department at **1-800-543-6163**.
- Custom orders non-refundable

### Suggested Specification

Tankless water heater shall be an Eemax model number \_\_\_\_\_.

Factory installation in a \_\_\_\_\_ (N4/N4X/N4X6) enclosure.

Enclosure to be fitted with the following features:

_____ <b>FP</b>	Freeze protection (-30°F)
_____ <b>EDS</b>	Non-fused disconnect
_____ <b>FDS</b>	Fused disconnect
_____ <b>EP</b>	Explosion proof (C1D2 compliant)
_____ <b>GFCI</b>	True RMS GFCI with digital display and reset
_____ <b>SK</b>	24" legs for free standing applications
_____ <b>SB</b>	Siren and Beacon
_____ <b>DC</b>	Dry contact
_____ <b>ES</b>	Emergency stop - push button

Tankless water heater must have water connections on the bottom and be constructed with NSF61 listed materials. Unit to accommodate vertical (upright) or horizontal mounting orientations. Heating element to be sheathed, copper cartridge style, designed for field replacement. Tankless water heater to use 4 line, 20 character LED digital display. Display to include selectable Celsius / Fahrenheit, inlet temperature, outlet temperature, and set point temperature. Display to be capable of relaying flow rate in gallons per minute or liters per minute. Diagnostic features to include error and fault code notifications via digital display. Control board to maintain error/fault history. Water heater must be protected by redundant safeties and redundant safeties to include employ integrated flow meter that will ensure accurate turn-on / turn-off flow rate. Unit shall have a 0.5 GPM turn on flow Water heater shall modulate power to the heating elements to maintain a user-selected output temperature between 60 - 180°F (subject to incoming water temperature). The unit shall be equipped with both computer-controlled and electromechanical auto resetting thermostat switches for high-limited temperature protection. Maximum operating pressure of 150 PSI. The water heater shall be fitted with 3/4" NPT fittings. Heater shall employ technology that engages upon start-up to avoid dry-fire occurrence. Unit shall be Eemax or approved equal.

# ProSeries XTP

Thermostatic Water Heater for Commercial and Industrial Applications

## Specifications

Tankless Electric Water Heater

MODEL NUMBER	KW	AMPS PER PHASE	RECOMMENDED WIRE SIZE (90° C/CU)	TURN ON (GPM)	MAX FLOW (GPM)	TEMPERATURE RISE °F										
						1.0 GPM	2.0 GPM	3.0 GPM	4.0 GPM	5.0 GPM	6.0 GPM	7.0 GPM	8.0 GPM	9.0 GPM	10.0 GPM	
<b>VOLTS 208</b>																
C	XTP018208	18	50	8 AWG	0.5	20.0	119°	60°	40°	30°	24°	24°	24°	24°	24°	20°
C	XTP024208	24	67	4 AWG	0.5	20.0	†	82°	55°	41°	33°	27°	23°	20°	18°	16°
C	XTP032208	31.2	87	3 AWG	0.5	20.0	†	107°	71°	53°	43°	36°	30°	27°	24°	21°
<b>VOLTS 480</b>																
C	XTP016480	16	19	12 AWG	0.5	20.5	109°	55°	36°	27°	22°	18°	16°	14°	12°	11°
C	XTP020480	20	24	10 AWG	0.5	20.5	137°	68°	46°	34°	27°	23°	20°	17°	15°	14°
C	XTP024480	24	29	10 AWG	0.5	20.5	†	82°	55°	41°	33°	27°	23°	20°	18°	16°
C	XTP027480	27	33	8 AWG	0.5	20.5	†	92°	61°	46°	37°	31°	26°	23°	20°	18°
C	XTP036480	37	43	8 AWG	0.5	20.5	†	126°	84°	63°	51°	42°	36°	32°	28°	25°
C	XTP048480	48	58	6 AWG	0.5	20.5	†	†	109°	82°	66°	55°	47°	41°	36°	33°
C	XTP054480	54	65	4 AWG	0.5	20.5	†	†	123°	92°	74°	61°	53°	46°	41°	37°

† Temperature electronically limited to factory preset temperature.

"C" indicates evaluation and compliance to either Underwriters Laboratories (UL) or Intertek (ETL) under CAN/CSA-C22.2 No. 64/No. 88.

### Base Model Dimensions

Est. weight 36 lb. Designed for wall mounted installation.

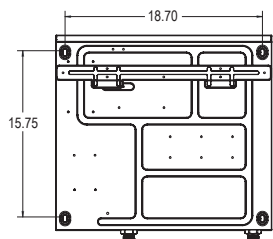
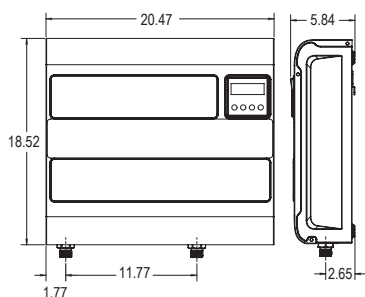

### Wall Bracket Dimensions

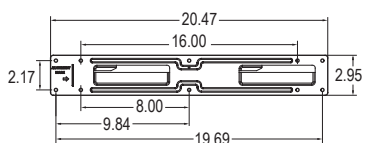

### NEMA Cabinet Options

**Dimensions:** 24"H x 30"W x 13.5"D

- N4** Powder coated steel
- N4X** Corrosion-resistant 304 stainless steel
- N4X6** Corrosion-resistant 316 stainless steel

Est. total weight 130 lb. Designed for wall mounted installation.

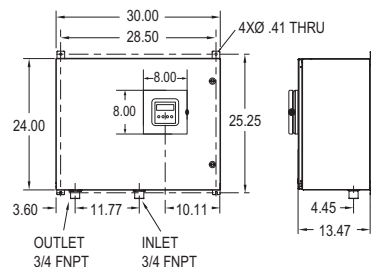

### NEMA Cabinet Options and Accessories

**Dimensions:** 36"H x 30"W x 17.3"D

- N4** Powder coated steel
- N4X** Corrosion-resistant 304 stainless steel
- N4X6** Corrosion-resistant 316 stainless steel

These options require the large cabinet:

- FP** Freeze protection (-30°F)
- EDS** Non-fused disconnect
- FDS** Fused disconnect
- EP** Explosion proof purge kit and vent (C1D2 compliant)
- GFCI** True RMS GFCI with digital display and reset
- SK** 24" legs for free standing applications
- SB** Siren and Beacon
- DC** Dry contact
- ES** Emergency stop - push button

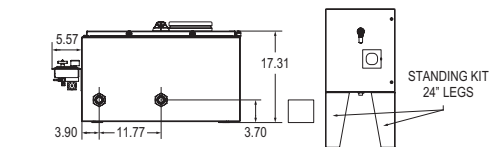
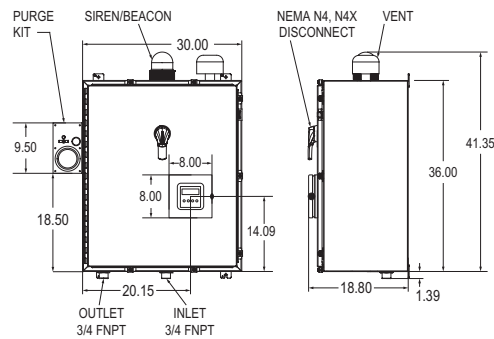

Est. total weight 225 lb, varies based on options. Designed for wall mounted installation. Free standing legs and other options available.